

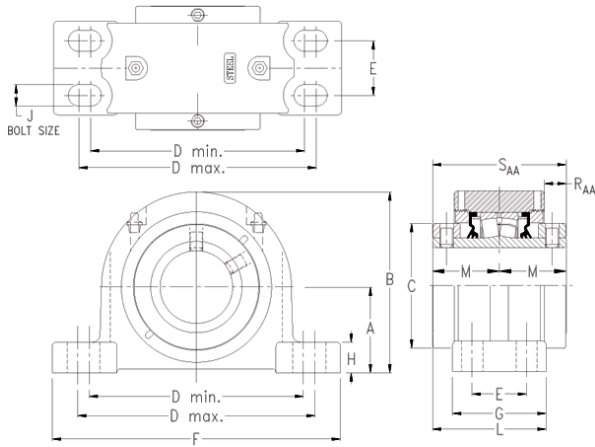

DGB BEARING IMPORTED LTD



timken QAAPF15A075S Solid Block/Spherical Roller Bearing Housed Units-Double Concentric Four-Bolt Pillow Block

Bearing No. QAAPF15A075S

Engineering Group	Mounted Bearing
Shaft Size	75 mm
Shaft Size Type	Metric
Full Timken Part Number	QAAPF15A075SB
Locking Style	Double Concentric
Weight	27 lb
Housing Style	Four-Bolt Pillow Block
UPC Code	0883450027106
Dimension A	3.25 in
Dimension B	6.60 in
Dimension C	4.29 in
Dimension D Max	9.10 in
Dimension D Min	7.60 in
Dimension E	1.88 in
Dimension F	10.44 in
Dimension G	3.130 in
Dimension H	1.29 in
Dimension J (Bolt Size)	0.625 in
Dimension L	3.94 in
Dimension M	2.37 in
Dimension RAA	0.88 in
Dimension SAA	4.74 in
C0 - Static Load	54100 lb
C - Dynamic Load (Basic)	49900 lb
e - Geometry Factor	0.22

QAAPF15A075S Bearing 2D drawings and 3D CAD models



DGB BEARING IMPORTED LTD

Y1 - Geometry Factor	3.14
Y2 - Geometry Factor	4.67
Oil Lubrication - M/N Seal	1600 rpm
Oil Lubrication - T Seal	2900 rpm
Oil Lubrication - B/C/O Seal	1300 rpm
Grease Lubrication - M/N Seal	1600 rpm
Grease Lubrication - T Seal	2400 rpm
Grease Lubrication - B/C/O Seal	1300 rpm
Float	0.083 in
Shaft Tolerance	0.0020 in
Eng Internal Radial Clearance - Min	0.0020
Eng Internal Radial Clearance - Max	0.0031
Pre Install Clearance Min	0.0020 in
Pre Install Clearance Max	0.0031 in