

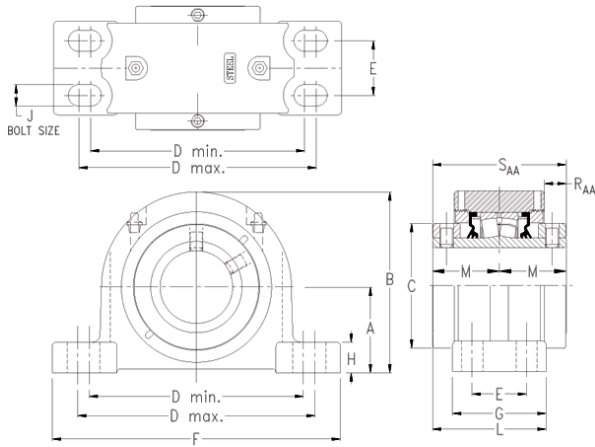

DGB BEARING IMPORTED LTD



timken QAAPF13A208S Solid Block/Spherical Roller Bearing Housed Units-Double Concentric Four-Bolt Pillow Block

Bearing No. QAAPF13A208S

Engineering Group	Mounted Bearing
Shaft Size	2-1/2 in
Shaft Size Type	Imperial
Full Timken Part Number	QAAPF13A208SB
Locking Style	Double Concentric
Weight	20 lb
Housing Style	Four-Bolt Pillow Block
UPC Code	0883450027007
Dimension A	2.75 in
Dimension B	5.8 in
Dimension C	3.81 in
Dimension D Max	7.63 in
Dimension D Min	6.88 in
Dimension E	1.75 in
Dimension F	9.250 in
Dimension G	3.0000 in
Dimension H	0.98 in
Dimension J (Bolt Size)	0.625 in
Dimension L	3.65 in
Dimension M	2.15 in
Dimension RAA	0.70 in
Dimension SAA	4.3 in
C0 - Static Load	48600 lb
C - Dynamic Load (Basic)	46400 lb
e - Geometry Factor	0.24

QAAPF13A208S Bearing 2D drawings and 3D CAD models



DGB BEARING IMPORTED LTD

Y1 - Geometry Factor	2.79
Y2 - Geometry Factor	4.15
Oil Lubrication - M/N Seal	1800 rpm
Oil Lubrication - T Seal	3200 rpm
Oil Lubrication - B/C/O Seal	1500 rpm
Grease Lubrication - M/N Seal	1800 rpm
Grease Lubrication - T Seal	2800 rpm
Grease Lubrication - B/C/O Seal	1500 rpm
Float	0.083 in
Shaft Tolerance	0.0015 in
Eng Internal Radial Clearance - Min	0.0016
Eng Internal Radial Clearance - Max	0.0026
Pre Install Clearance Min	0.0016 in
Pre Install Clearance Max	0.0026 in