

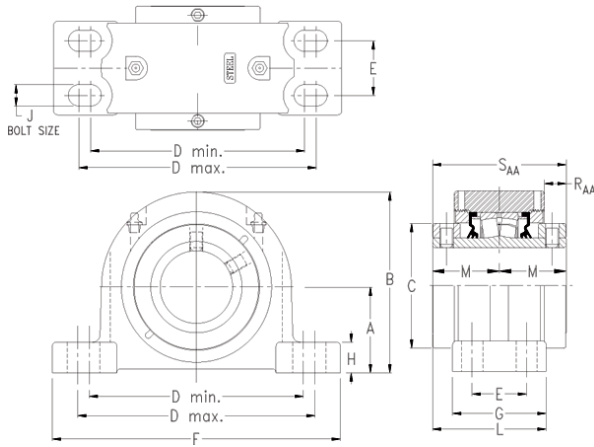

DGB BEARING IMPORTED LTD



timken QAAPF18A085S Solid Block/Spherical Roller Bearing Housed Units-Double Concentric Four-Bolt Pillow Block

Bearing No. QAAPF18A085S

Engineering Group	Mounted Bearing
Shaft Size	85 mm
Shaft Size Type	Metric
Full Timken Part Number	QAAPF18A085SB
Locking Style	Double Concentric
Weight	49.0 lb
Housing Style	Four-Bolt Pillow Block
UPC Code	0883450320214
Dimension A	3.75 in
Dimension B	7.69 in
Dimension C	5.13 in
Dimension D Max	10.88 in
Dimension D Min	8.88 in
Dimension E	2.00 in
Dimension F	12.30 in
Dimension G	3.7500 in
Dimension H	1.56 in
Dimension J (Bolt Size)	0.750 in
Dimension L	4.47 in
Dimension M	2.59 in
Dimension RAA	0.84 in
Dimension SAA	5.18 in
C0 - Static Load	87200 lb
C - Dynamic Load (Basic)	79700 lb
e - Geometry Factor	0.23

QAAPF18A085S Bearing 2D drawings and 3D CAD models



DGB BEARING IMPORTED LTD

Y1 - Geometry Factor	2.90
Y2 - Geometry Factor	4.31
Oil Lubrication - M/N Seal	1400 rpm
Oil Lubrication - T Seal	2400 rpm
Oil Lubrication - B/C/O Seal	1000 rpm
Grease Lubrication - M/N Seal	1400 rpm
Grease Lubrication - T Seal	2000 rpm
Grease Lubrication - B/C/O Seal	1000 rpm
Float	0.083 in
Shaft Tolerance	0.0030 in
Eng Internal Radial Clearance - Min	0.0024
Eng Internal Radial Clearance - Max	0.0039
Pre Install Clearance Min	0.0024 in
Pre Install Clearance Max	0.0039 in